



Human Computer Interaction

interaction design

Lecture No. 6

Dionysios Politis
Dept. of Informatics



European Union
European Social Fund



MINISTRY OF EDUCATION & RELIGIOUS AFFAIRS
MANAGING AUTHORITY

Co-financed by Greece and the European Union



License

- This educational material is subject to Creative Commons licensing.
- For educational material such as images, that subjects to another form of licensing, the license is explicitly referred.



Funding

- This educational material has been developed as part of the educational work of the academic teacher.
- The project “Open Academic Courses at the Aristotle University of Thessaloniki” has only funded the reconfiguration and reshaping of the educational material.
- The project is implemented under the Operational Program “Education and Lifelong Learning” and is co-funded by the European Union (European Social Fund) and National resources.



Human Centered Design

in Action, in Practice



Cloud, what is it?

- Cloud computing, or simply the “cloud” in our everyday computer jargon, is an extended, worldwide spread structure, which gives us the ability to access and use handy web applications that extend our computer’s functionality without burdening local resources.
- Within this nebulous formation, a network of remote servers is utilized for storing, managing or processing data that otherwise would be dispatched by a local server or a personal computer.
- The “cloud” is a factor that gives added value to mobile devices.



Web 3.x (1/2)

Within Web 3.x :

- machines become “smarter”. The search and the information correlation acquires new dynamics allowing natural language queries (semantic web)
- Social Networking searches lead to the personalization of information
- Information delivery evolves as fully autonomous from the content format and allows the presentation of different forms, through different channels and with different integration (xml, rich media and multimedia, semantic web, ...)
- Infrastructures promote the fully autonomous use of equipment, enabling simultaneously a variety of everyday-used machinery to be part of gigantic “clouds” or the “Internet of Things”
- Spatial information becomes a parameter affecting the information generated by varying the form and content (geo-localization)



Web 3.x (2/2)

- The Web 3.x is the so-called next generation Internet with intelligence, where the search and collection of information about semantic and conceptual processing is promoted, instead of keywords used hitherto
- Computers can understand exactly what you are looking for - instead of simply recognizing keyword characters and combine data effectively, avoiding to provide unnecessary Internet information



In action

- The revolution that took place on new computing devices (as far as their Metaphors, Paradigms, Idioms are concerned ...) improves the interaction with the device and the cloud.
- We have a new Interaction Design without creating a new Metaphor.



Metaphor diachrony

- The desktop metaphor was first introduced by Alan Kay at Xerox PARC in 1970 and commissioned a range of innovative software applications developed by scientists at PARC throughout the decade that followed
- The first computer was using an early version of the desktop was the Xerox Alto
- The first computer that made the desktop well known was the Apple Macintosh in 1984
 - The desktop exists in all modern PCs
 - Located in most environments of modern desktop operating systems

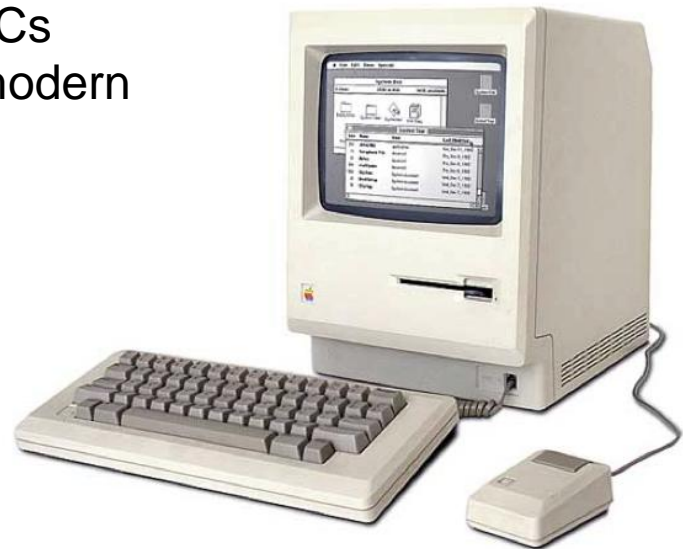

Interaction for People with Disabilities (PWD)



Types of Disability

- There are multiple degrees and types of disability but those that interest us the most are:

- Vision Problems
- Hearing Difficulties
- Mobility Problems
- ...
- Linguistic Problems
- Multiple Problems

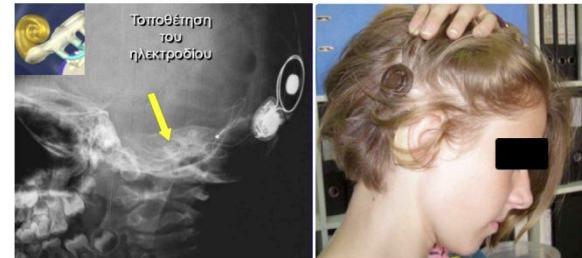

Brain Computer Interfaces (BCIs)



Interaction Design Guidelines *(1/3)*

- The software should be designed to be accessible without requiring extra adaptive software or hardware.
- Software should be designed to work with special access features that users will have to recognize compatibility in the software they use.
- Ensure documentation, learnability and training (if needed).



Interaction Design Guidelines (2/3)

- Hardware and software for people with disabilities leads to augmentation ...

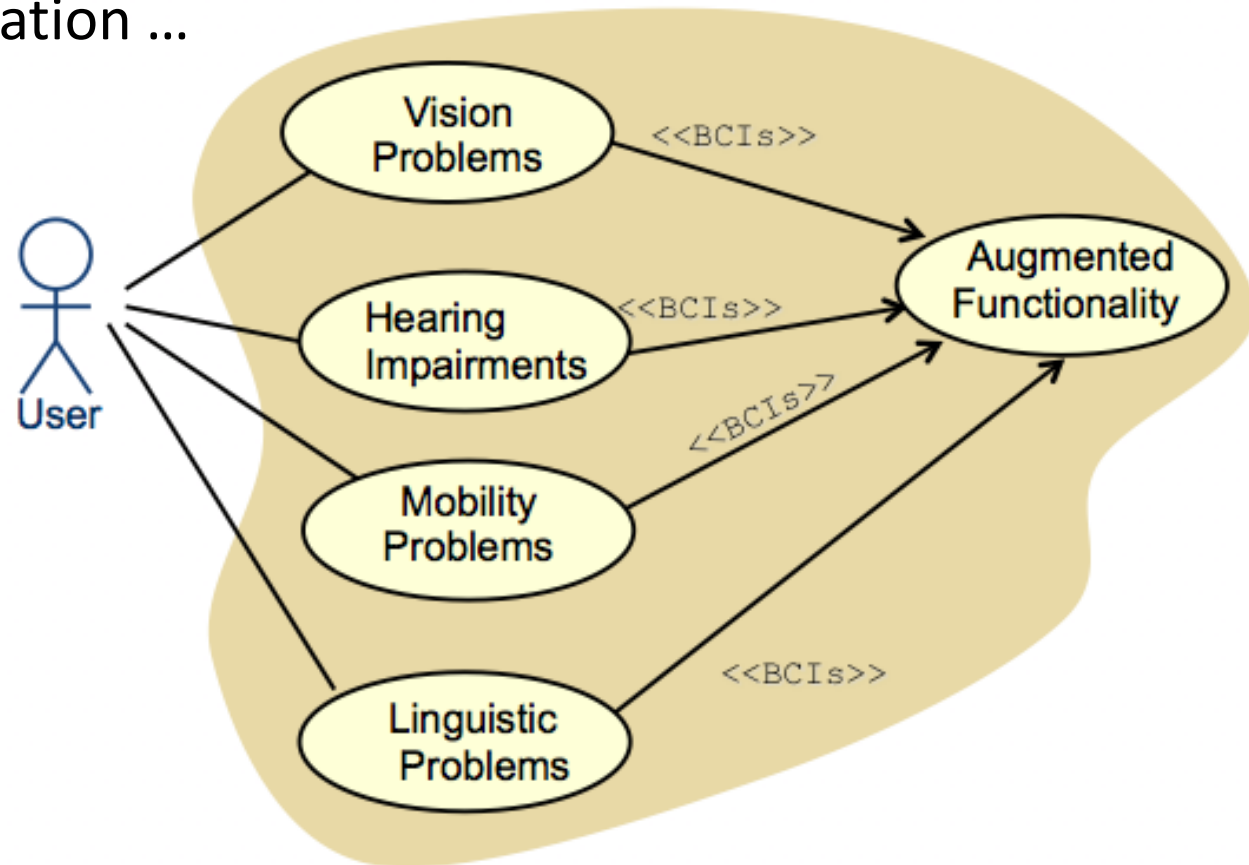

Interaction Design Guidelines (3/3)

Engineers and Medical Personnel involved with augmentation seek to ameliorate Internal Quality, External Quality and ultimately, the overall Quality in Use.



Source: Cochlear's Nucleus

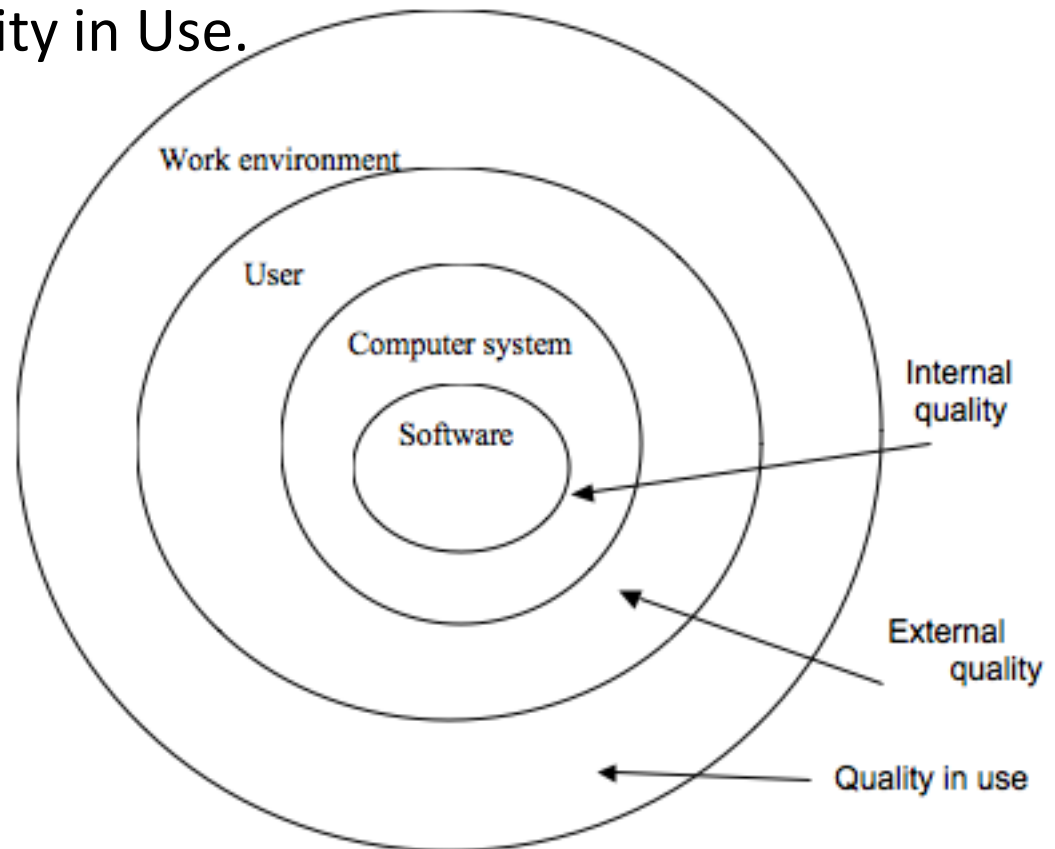

General Design

- From the world of aids and prostheses for the impaired, usable solutions have been promoted to the general public.
 - The tools used are easily identifiable.
 - They maintain a consistent, predictable layout and a behavior adherent to the OS's standards.
 - Provide access to menus, keyboard, tools, etc.



Keyboards

On Screen Keyboards:

- Screen Keyboard is a utility that displays a virtual keyboard on the screen and allows users with mobility impairments to type data using a pointing device or joystick. Screen Keyboard is intended to provide a minimum level of functionality for users with disabilities.



Alternate Keyboards:

- Keyboards with different sized keys, a different key arrangement and keyboards that can be used by a single hand.



Mini keyboards

Magic Wand Keyboard™ :

- It comprises a miniature keyboard with integrated mouse. It allows people with disabilities or practical difficulties to access the computer
- It is designed to be used with limited or no movement of the hand at all and it is the only keyboard and mouse requiring no power.
- Works with the smallest touch of a small stick (or kept in hand or mouth), and absolutely requires no power.



Alternate Virtual Keyboards

- Keyboard for the left-handed:

~	{	}	?	P	F	M	L	J	\$	#	@	!	←
`	[]	/						4	3	2	1	Backspace
Tab	:	Q	B	Y	U	R	S	O	>	^	%	+	
↔	:								.	6	5	=	
Caps Lock	-	K	C	D	T	H	E	A	Z	*	&	Enter	
↑	-									8	7	↵	
Shift	"	X	G	V	W	N	I	<)	()	Shift	
↑	'								,	0	9	↑	
Ctrl	Win Key	Alt								Alt Gr	Win Key	Menu	Ctrl

- Keyboard for the right-handed:

~	!	@	#	\$	J	L	M	F	P	?	{	}	←
`	1	2	3	4									Backspace
Tab	%	^	Q	>	O	R	S	U	Y	B	:	+	
↔	5	6		.							:	=	
Caps Lock	&	*	Z	A	E	H	T	D	C	K	-	Enter	
↑	7	8									-	↵	
Shift	()	X	<	I	N	W	V	G	"		Shift	
↑	9	0	,									↑	
Ctrl	Win Key	Alt								Alt Gr	Win Key	Menu	Ctrl

- Alternate Keyboard:

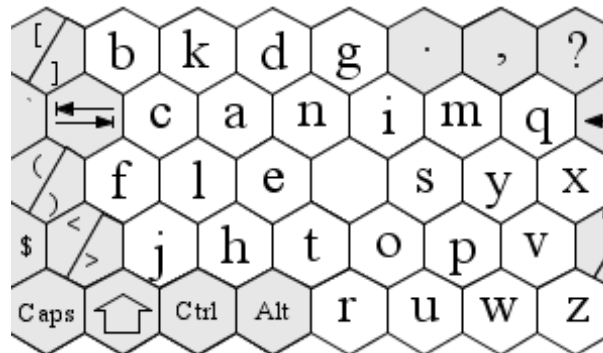

The Interaction Model with Input-Output Devices

- The constituent parts of Interaction:

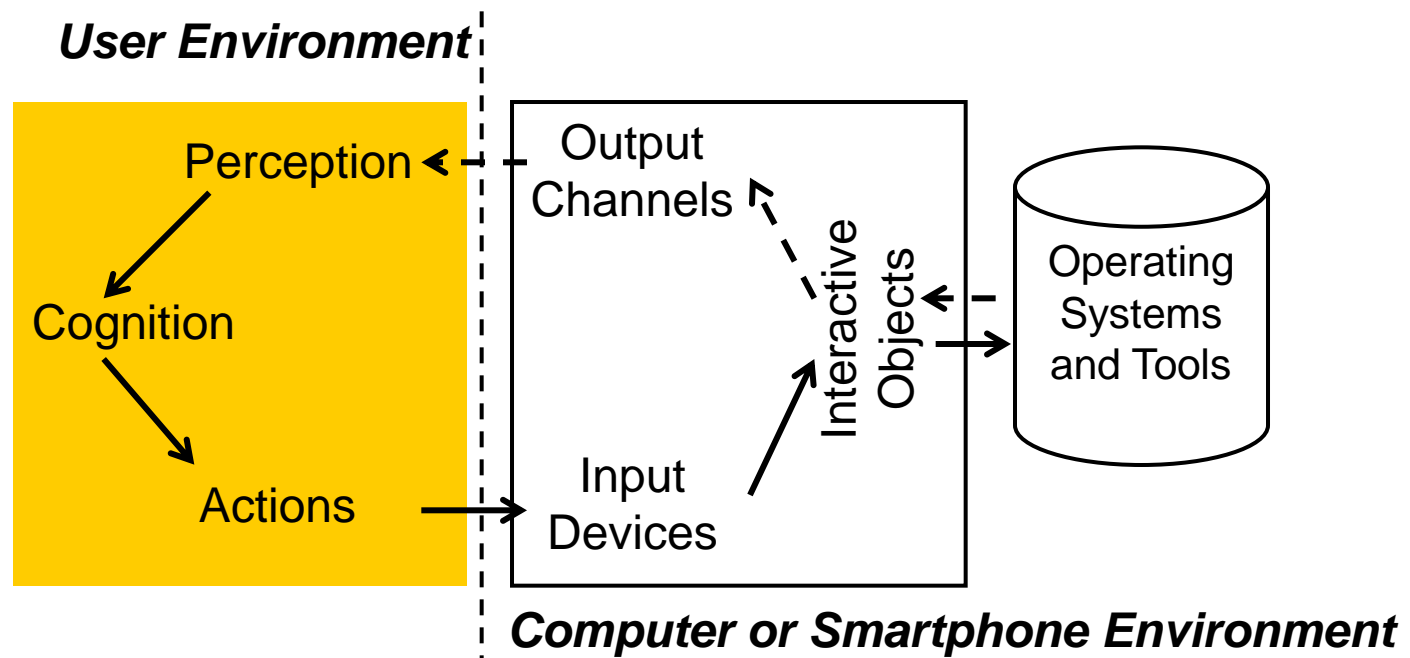

A Generative Interaction Model

- First introduced as a conceptual model by Foley, Wallace and Chung in 1986.
- Web 3.x interoperability has been added.
- In its present form it hosts the following Interactions:

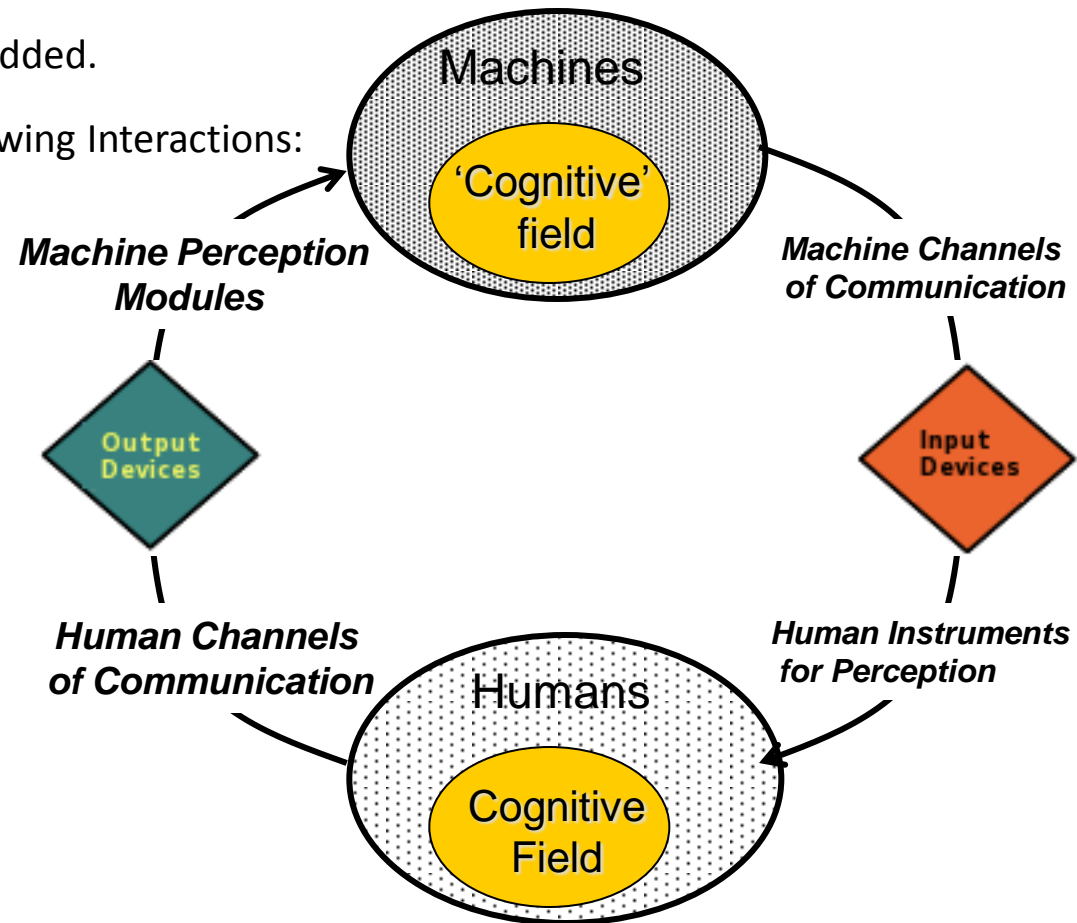

Norman's Model

A long lasting model that gives a conceptual interpretation for Interaction is Norman's Model:

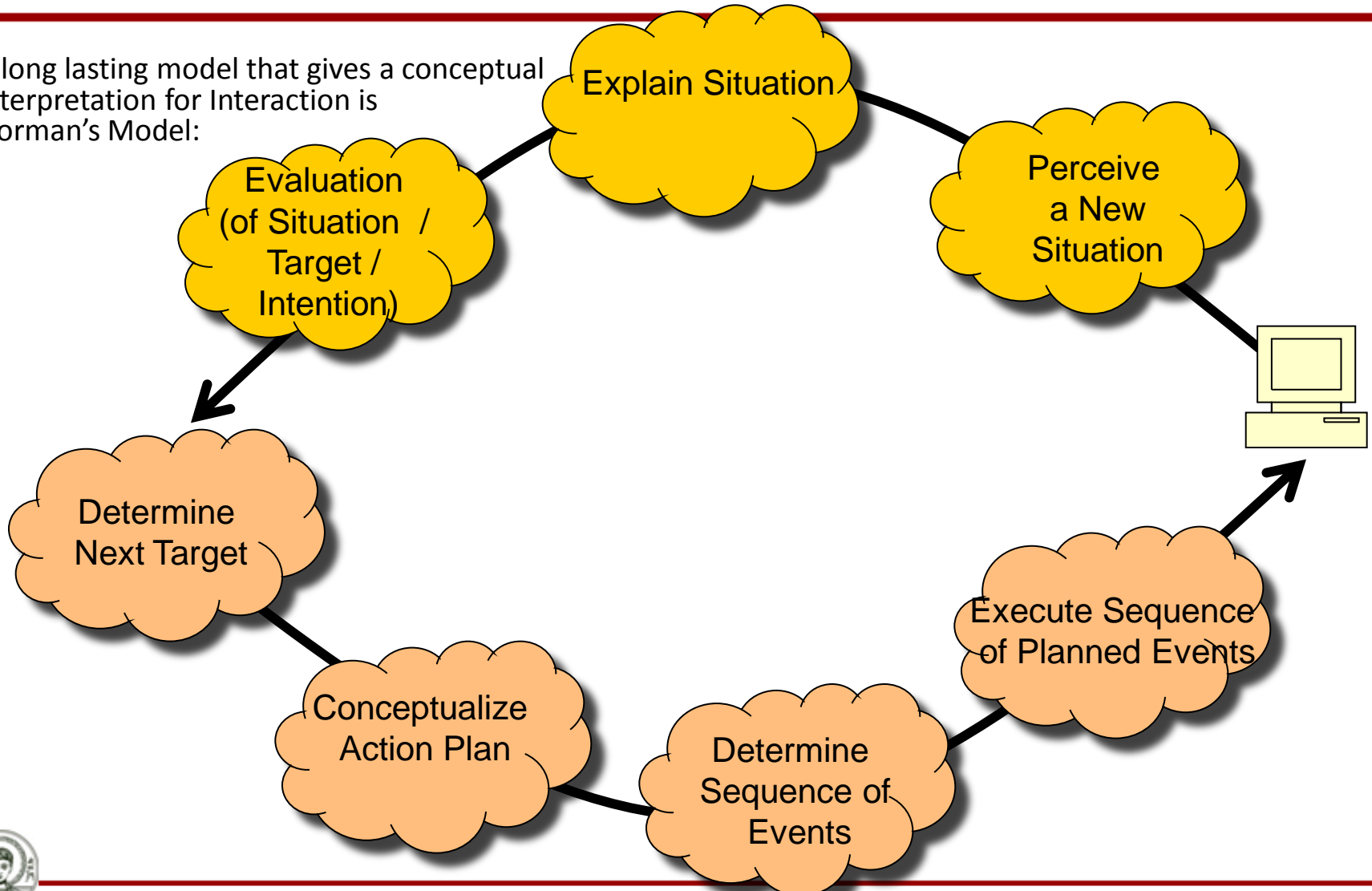

Measurements and Evaluation

- The Interaction procedures can thus be quantified and measured:

	<i>Action</i>	<i>Time (sec)</i>
<i>Natural moves</i>	Type by pressing key (of keyboard or (virtual) pointing device)	$T_K = 0.28$
	Transfer the cursor of the pointing to the desired location on screen	$T_P = 1.1$
	Motor action (movement) of hand towards keyboard, pointing device or function key.	$T_H = 0.4$
<i>Mental calculations</i>	Mental preparation	$T_M = 1.35$
	Select between alternative methods	$T_S = 1.2$



Instrumentation: Mini keyboards

- Intel has created an application that allows to control the computer remotely, either in the same room or any other room in the house.
- The Remote Keyboard™ converts the Android smartphone or tablet to the keyboard, allowing the user to enter and move the mouse, without having to move from its position.
- A single finger tap on the screen acts as a "left-click" the mouse while double as the "right click" the mouse.

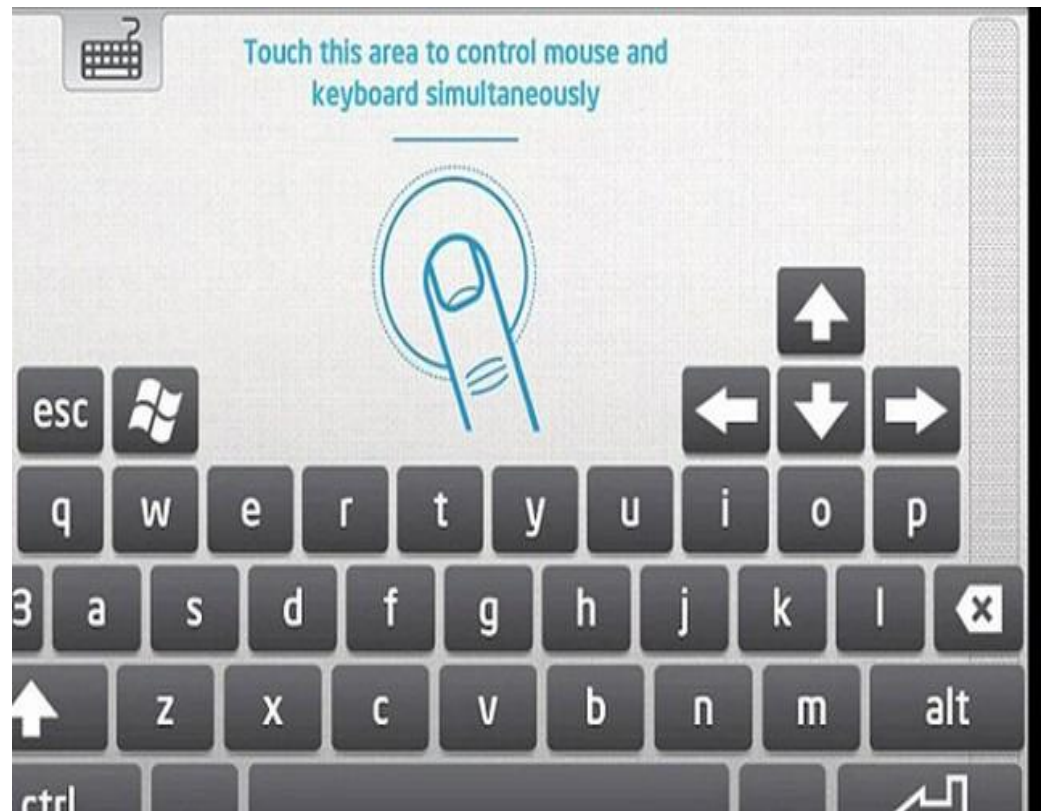

Source: ApkThing.com



Instrumentation: Pointing Devices

- **Facility Hardware and Software for “Click”:** it provides help in selecting the type of mouse click (left, right, double, drag and drop, etc.). Users who are unable to click the mouse buttons via the software or hardware, they can click simply by moving the mouse.
- **Mouse Simulators:** allows the replacement of the mouse from other devices, for example, joystick or multirole, multifaceted keyboard.



Speech Recognition Applications

- There are two important uses speech recognition systems (speech recognition systems):
 - dictation, where sequences of spoken words uttered by the user are converted into written text, and
 - control, where the user can control and guide the computer, along with various software applications giving verbal commands.
- Speech recognition is often considered as an auxiliary authoring tool for people with cognitive impairments such as:
 - dyslexia (a disorder affecting linguistic communication, involving difficulty in learning to read or interpret words, letters, and other symbols. It affects written communication as well.)
 - dysgraphia (inability associated with writing coherently, as a consequence of brain damage, where the patient has difficulty in attaining the proper form of letters or writing within a pre-defined space.)
- Some diachronically well-known speech recognition applications:
 - the Dragon Naturally Speaking product (Nuance Dragon Inc.)
 - the Via Voice for Windows, by IBM
 - Voice Xpress, by Lernout & Hauspie



iPad & applications for People With Disabilities

- VoiceOver is a characteristic important function launched by the iPhone and Touch iPod, and touching the screen with your finger converts visual text into audio for visually impaired users.
- The VoiceOver software is not only available for iPad's operating system, but also for its applications.
- If the user's hearing is limited in one ear, the iPad offers the choice of mono:
 - This application allows the user to take any audio data in one ear, and can be combined with special headphones iPad, making it even easier to use for people with hearing problems.
- There are now many developers who create applications that appeal to users with disabilities, and the number of these applications multiply by the day.
- The next step is to bridge the applications intended for users with disabilities to those that offer mainstream content.



Cloud and PWD education

- The cloud has penetrated and level of education making it accessible to all people and especially people with disabilities.
- Cloud and native (i.e. using local resources) apps provide a multifactorial amplification x10 for computer based applications that have a focus in medical terms.
- Learnability is key factor for promulgation and special recognition.

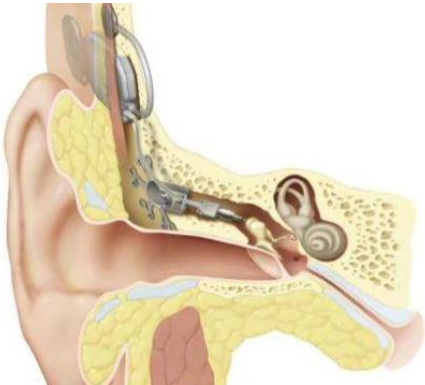

Source: Otologics Carina

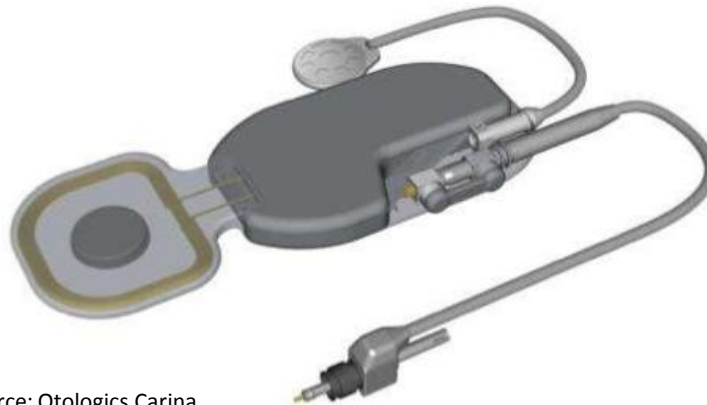

Conclusion

- People with disabilities have difficulties in all levels of their daily lives.
- Providing hardware and software solutions for these people is critical for the Interaction Design industry.
- Apart from helping the societal integration of hundreds thousands of people worldwide, this specific approach promotes new Interfaces and new Design Methodologies for the mainstream Interaction market as well.
- The “cloud” is a new factor that is enabling and enhancing Multimedia Interaction Design (e.g. via the new features of Social Networks).
- Brain Computer Interfaces bring advanced interoperability to everyday users with a plethora of devices like
 - Google Glasses
 - Cochlear implants
 - Oculus Rift



Source: Google & MEDEL



End of the 6th Lecture

Sources :

- D. Akoumianakis, COMPUTER-USER INTERFACE – a modern approach
Kleidarithmos Publications , Athens 2006 (in Greek)
- B. Schneiderman & C. Plaisant, Designing the User Interface: Strategies for Effective Human-Computer Interaction
5th Edition, Pearson, 2009
- J. Preece, Y. Rogers, H. Sharp, INTERACTION DESIGN – beyond Human-Computer Interaction
4th Edition, John Wiley & Sons, 2015
- N. Avouris, INTRODUCTION TO HUMAN-COMPUTER INTERACTION
Diavlos Publications, Athens 2000 (in Greek)



Reference note

Copyright Aristotle University of Thessaloniki[©], **Human Computer Interaction – Interaction Design – Lecture 6: “Human Centered Design in Action, in Practice”**.

Version: **1.0**. Thessaloniki 2016.

Available from the web address: <http://delos.auth.gr>



Licensing note

This material is available under the terms of license Creative Commons Attribution [1] or later, International Edition. Excluding independent third-party projects e.g. photos, diagrams, etc., which are contained therein and are reported together with their terms of use in “Third Party Works Vitae”



The beneficiary may provide the licensee separate license for commercial usage of this work under request.

[1] <http://creativecommons.org/licenses/by/4.0/>

